

# PENTHO COMPACT 3

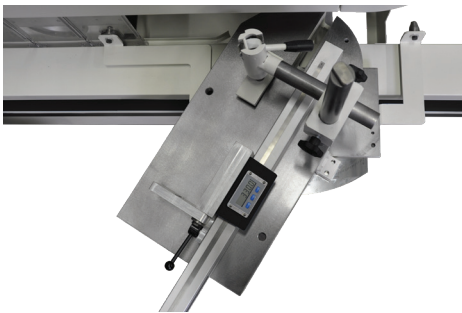

## UNIVERSAL TENONER

The Pentho Compact 3 has a noise-reduced cut-off saw, tenon heads and one vertical spindle. The machine has a solid table on a stable vertical slide bar. The cut-off capacity of the machine is 150 mm. The total table can be swivelled +/- 60° in two directions. The machine has a dust rejecting transparent safety-screen that moves together with the table and covers the machine completely .



The table can be swivelled 60° in two directions. The working area of the table does not change.

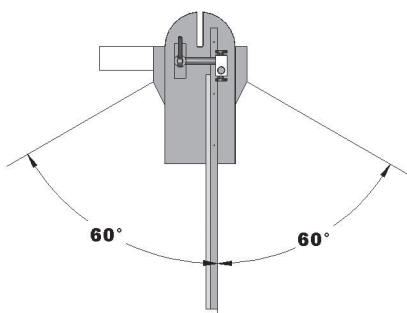

7" touch panel for the operation of the machine and starting of all motors

The safety-screen covers the complete machine. Loading and unloading still remains easy.



The spindles are horizontally and vertically adjustable with 0,1 mm accuracy.

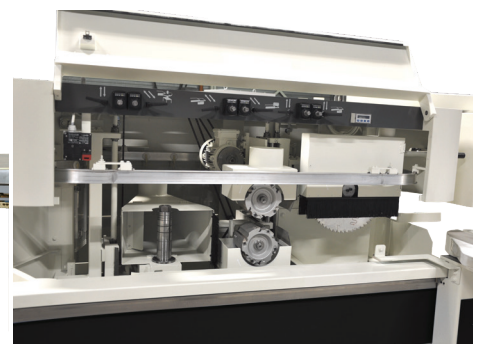
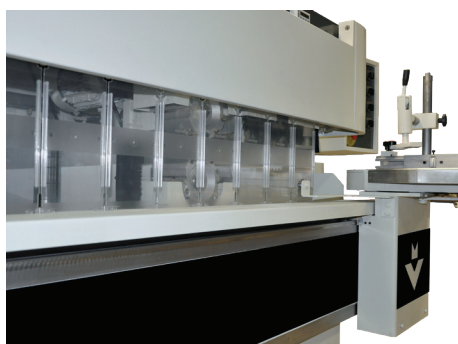

# PENTHO COMPACT 3



## TECHNICAL DESCRIPTION

### GENERAL

7" touch panel:	For the operation of the machine Selecting of all motors by the panel
Security:	Conform CE.
Dimensions:	2200 x 1700 x 1600 mm
Total extraction:	1 x Ø 80 mm, 3 x Ø 150 mm

### TABLE

Table mounting:	Vertical attached, extra solid
Movement:	Manual; automatic movement option
Table:	Swivelling +/- 60°, fixed in height
Backing wood:	Clamp for straight backing wood; Round backing wood option
Clamps:	Manual acting clamp vertical; Pneumatic clamps vertical option
Length fence:	2.4 m; 3.4 m optie; automatic length-fence option
Dimensions:	160 mm x 600 mm (usefull)

### CUT OFF SAW

Motor:	2,2 kW - 3000 tpm
Adjustment:	Hor. 20-155 mm ,cut-off capacity 150 mm
Tool:	Noise reduced saw included, diam. 400 mm
Extraction:	Diam. 80 mm
Positioning:	Manual on slide bearings
Reading:	Mechanical; digital read-out or laser option

### TENONING HEADS

Motor	2 x 2,2 kW
RPM:	4500
Susmension:	Slide bearings
Reading:	Mechanical digital counter on front of machine
Tooling:	Tenon heads included Ø 160 mm, length 145 mm, exchangeable knives
Extraction:	2 x 150 mm diameter
Movement:	Horizontal upper -55 / +25 mm, lower -55 / 0 mm Vertical upper +3 / +150 mm, lower -2 / +80 mm

### VERTICAL SPINDLE

Motor	7,5 kW
RPM:	4000
Suspension:	Dove tail
Reading:	Mechanical digital counter on front of machine
Movement:	Horizontally 150 mm, vertical -150 - +25 mm
Spindle length:	200 mm with Prolock; 300 mm x 50 mm with Prolock only with HP
Spindle Ø:	Ø 40 or Ø 50 mm
Tool Ø:	Max. Ø 350 mm
Extraction:	150 mm diameter

## OPTION

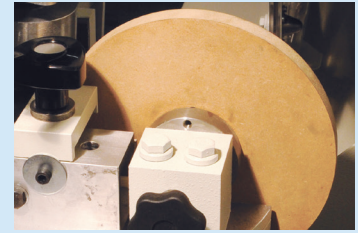

Round backing wood with 6 manual adjustable positions.

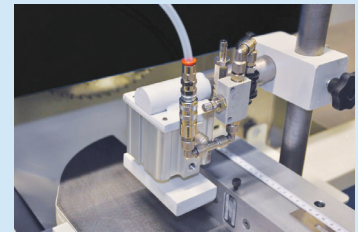

Vertical pneumatic clamb

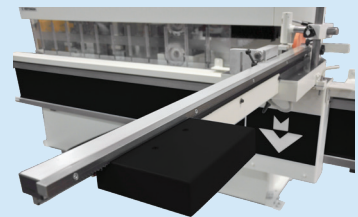

Automatic length-fence

## PERFORMANCE



## HIGH PERFORMANCE

